

# SHARP

Be Original.

**BP-30M35**  
**BP-30M31**  
**BP-30M28**

Digital Multifunction System

**Built to Meet Your Flexible  
New Working Style**



# Powerful features that keep you in touch

The way we work—and where we work—is changing fast, so we need new ways to connect and share information smoothly and securely. That's where this MFP comes in. It's a smart and flexible solution for all your business-essential document needs. Even though it's packed with advanced technology, it's easy and intuitive to use. Whether in the office or beyond, your team will enjoy a streamlined workflow.



## EASIER CONNECTION



Work seamlessly whether you're in your office, at home, or in a remote location. Cloud and mobile connectivity let you keep on top of changes in business.

### Wireless Connectivity\*

The MFP offers ultra-handry wireless access, enabling convenient access to the MFP even from places where it's difficult to connect a LAN cable.

\*Requires optional MX-EB18. Availability of this option varies by country/region.

### Link with Mail Servers

Scanned data can be conveniently sent via your regular Gmail™ or Microsoft Exchange/Online\* account.

\*Exchange Server 2010/2013/2016, Exchange Online

## FASTER RESULTS



Get your document jobs done smoothly and efficiently with an MFP that packs a full suite of business features that get the most out of your data.

### Office Direct Printing\*

Even without a PC, you can print common Microsoft® Office files directly from a mobile device, cloud service, USB drive, or file server.

\*Requires optional MX-PU10. The actual printout may look different from what is displayed on the computer screen. This function is enabled via Qualcomm® DirectOffice™ technology.

### OCR Function\*

OCR capability on this MFP lets you convert a scanned document into a searchable PDF file or editable Office Open XML file.

\*Requires optional MX-EB20.



## GREATER EASE



We've designed this MFP to be accessible and easy to use for anyone on your team. It wakes up fast and handles a wide range of tasks.

### Fast Wake Up

Placing a document in the RSPF or touching the LCD control panel wakes the MFP up from Sleep mode in just one second\*.

\*When in Fast Wake Up mode.

### Easy UI Mode

In Easy UI mode, the touchscreen displays simple icons for frequently used functions like duplexing and paper size selection.

## STRONGER SECURITY



A range of powerful security features keep your confidential business information safe, whether it's in a document, on the MFP, or on your network.

### Data Encryption and Erasure\*

Job data is encrypted before being saved to the MFP's internal storage. Once the data is output or sent, it is automatically erased.

\*Contact a Sharp customer representative for details on activating these functions.

### Whitelisting

Whitelisting protects the MFP from fraudulent programs trying to access the file system and obtain information.

# EASIER CONNECTION

- Want to keep up with diversifying work styles
- Want to print from or scan to devices other than PCs
- Want to access the company system from outside the office

## Link with Mobile Devices\*

Connecting the MFP to one or more mobile devices is easy, and it expands your options for sharing data. Not only can you send scanned documents to mobile devices such as smartphones and tablets, you can also print documents or photos sent from those devices.

\*Requires wireless LAN connection or optional MX-EB18. Availability of this option varies by country/region.



### Sharpdesk Mobile\*<sup>1</sup>

This print/scan app lets you easily link your mobile device to the MFP by simply holding it over the MFP's NFC card reader\*<sup>2</sup> or by scanning the MFP's QR Code.

\*1: Availability varies by country/region. For details, see the support website:

[https://global.sharp/products/copier/docu\\_solutions/mobile/sharpdesk\\_mobile/](https://global.sharp/products/copier/docu_solutions/mobile/sharpdesk_mobile/)

\*2: The NFC interface is for Android™ devices running Android 9 or earlier. Requires third-party NFC card reader. Contact a Sharp customer representative for details.

### AirPrint\*

The MFP supports the AirPrint printing feature in Apple devices. It lets you print directly from a mobile device without the need for a printer driver.

\*Requires optional MX-PK13.

## Link to Cloud Services\*<sup>1</sup>

The MFP connects with cloud services directly from its control panel, letting you upload scanned data to or print directly from any of them\*<sup>2</sup>. Once you log in to the MFP, its single sign-on feature allows you to quickly access multiple software services without having to sign in to each one separately. You can also download and install apps on your MFP via Sharp's Application Portal. App updates are easily recognisable, so you'll always be up-to-date on the latest services.

\*1: Requires optional MX-AMX2. Contact a Sharp customer representative for details.

\*2: Direct printing of PDF files requires optional MX-PK13; direct printing of Microsoft Office (pptx, xlsx, docx) files requires optional MX-PU10.

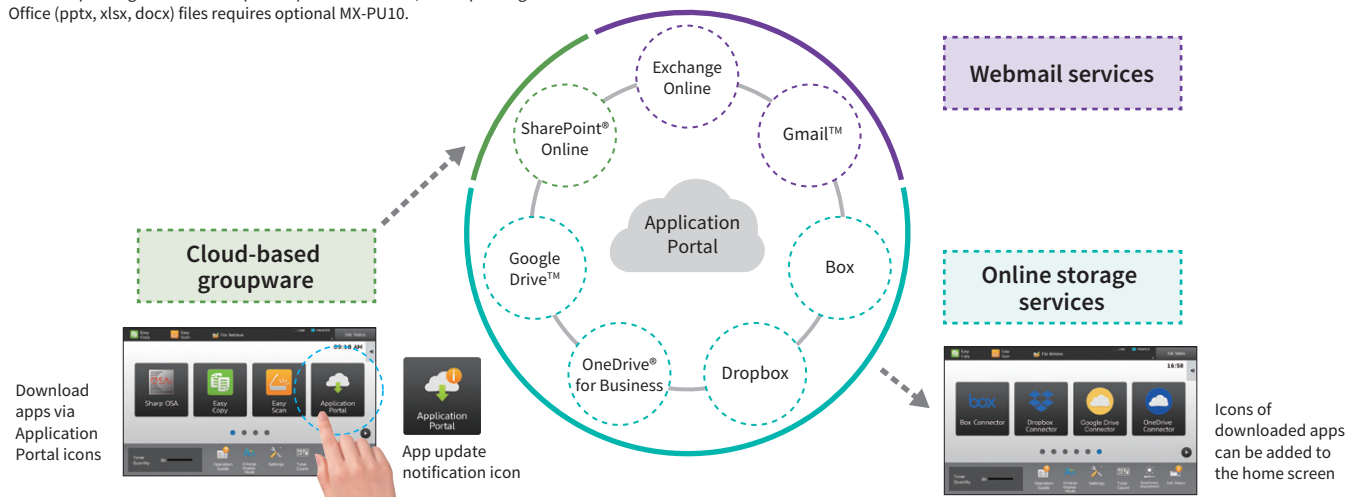

## Sharp OSA\* (Open Systems Architecture)

Sharp OSA technology allows you to interact with intra-company systems and network applications right from the LCD control panel. And since Sharp OSA utilises industry-standard network protocols, the MFP can easily integrate with third-party document management systems, enterprise resource planning software, workflow applications, and more.

\*Requires optional MX-AMX2 and/or MX-AMX3.



## Remote Operation\*

The Remote Operation function lets you display the MFP's main control panel on the screen of your PC or mobile device. From a remote location, you can then check MFP settings or reprint data stored on the MFP.

\*Requires VNC application. Simultaneous remote operation from two or more PCs or mobile devices is not possible. Remote operation also depends on the network environment and applications being used. Contact a Sharp customer representative for details.

# FASTER RESULTS

- Want to streamline business processes
- Want to use digital data effectively
- Want to make the whole office more productive

## Automatic Document Feeding

An RSPF (reversing single pass feeder) efficiently feeds in up to 100 sheets of either one- or two-sided originals. With a scanning speed of up to 60 opm\* (one-sided) for both colour and B/W documents, the MFP can complete large jobs with ease and efficiency.

\*Originals per minute; when feeding A4 (8 1/2" x 11") sheets



## Multiple Scan Destinations

Scanned documents can be distributed in a number of ways. A compact PDF function\*<sup>1</sup> ensures that PDF files are sent and received smoothly. When you're scanning large-volume documents, the MFP saves the data on its solid-state drive and generates a URL for accessing and downloading that data. You can then email recipients this URL, thereby reducing the load on the mail server.

\*1: Requires optional MX-EB19.

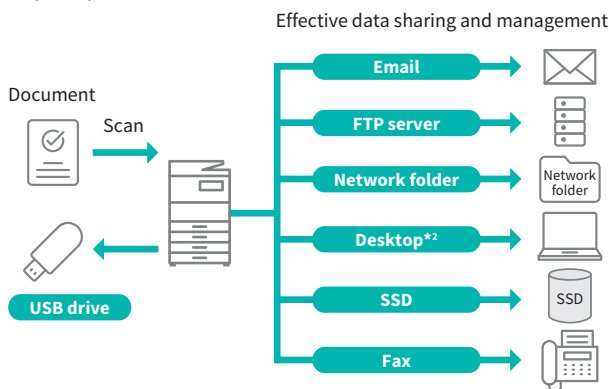

\*2: Requires Network Scanner Tool Lite.

## Document Filing

Document Filing allows files that have been copied, printed, scanned, or faxed\* to be stored by job in a Quick File folder, Main folder, or Custom folder on the MFP's solid-state drive. From there, they can be instantly recalled for printing and sending at a later time.

\*Fax requires optional MX-FX15, and Internet fax requires optional MX-FWX1. For fax and Internet fax jobs, only transmitted data (not received faxes) can be saved via the Document Filing function.

## Card Shot Function

The MFP lets you easily copy both sides of a card onto a single page. Whether it's an ID card or a driver's license, you save time, effort, and paper.

## Network Scanner Tool Lite\*

This lets you send documents scanned on the MFP to your PC or mobile device and save them in a specified folder there. It can even work if you're out at a client's office. Network Scanner Tool Lite can detect the nearest MFP and let you upload scans to your laptop or mobile device. There's no need to make special settings.

\*Download from the following website:  
<https://global.sharp/products/copier/downloads/>

## Business Card Scanning\*

The MFP can scan multiple business cards at once. It reads the contact details on each card via OCR\* and then exports the details to your chosen contact management system.

\*Requires optional MX-EB20.



## Multicrop and Image Crop Functions

Multiple receipts, photos, and other items can be scanned all at once, with each one saved as a separate file. This helps you streamline the filing of receipts and bills. The MFP can also crop photos from documents such as magazine pages and save them as individual files.

## Print Release\*

The Print Release function lets you send documents to the main MFP. This MFP acts as a server and stores them for printing out from any other compatible MFP on the network. The document won't be output until you log in to the MFP, select the document, and execute a print command. Print Release is easy to set up for admin staff and doesn't need a separate server.

\*Contact a Sharp customer representative for details on the recommended maximum number of connectable MFPs.

## Space-Efficient Inner Finisher

With the help of this finisher option, the MFP can handle document sorting and stapling jobs with ease.



# GREATER EASE

- Want a smooth user experience
- Want neat, high-quality output
- Want an environmentally friendly workplace

## 7.0-Inch LCD Touchscreen

Operating the MFP is easy and intuitive with the 7.0-inch colour LCD touchscreen. Just tap your dedicated user icon to access a personally customised operation screen. And with the Advanced Preview function, you can check document finishes, edit pages in advance, and more.

## Quick MFP Status Check

On the control panel are two LED lamps: one green, one red. These light up to notify you—even from a distance—that, for example, the machine is “now printing” or “out of paper.”

## Pop-up Command Screen

Insert a USB drive into the MFP and a command screen will automatically pop up on the LCD. Right away you can print files from the USB drive—which are displayed as thumbnails\*—or you can scan documents directly to the USB drive.

\*Previews of Microsoft Office files require optional MX-PU10.



## Secondary Ethernet Port\*

A secondary Ethernet port allows the MFP to support two separate networks. You can set up different IP addresses and security settings for each line—one in-house, say, and one for visitors. Alternatively, the MFP could be set up to access a web-connected office network as well as a high-security offline network.

\*Requires an Ethernet adaptor that supports two lines. Contact a Sharp customer representative for details.

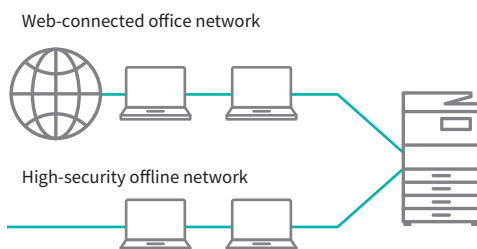

## Energy Efficient

This MFP conforms to the ENERGY STAR® programme. To reduce power consumption, Sharp has applied its advanced technologies across all areas of this MFP. Energy-saving functions include a low power consumption of only 0.5W\* in fax or network standby mode.

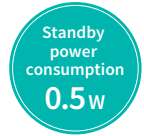

\*May vary depending on usage environments.

## Automated Scanner Settings\*1

Tap on the LCD touchscreen’s Auto Set button to have the MFP perform a host of actions automatically. It can determine scan resolution, skip blank pages in a multi-page document, or reorient pages mixed in upside down\*2. Automatic functions like these save you time and effort, while ensuring optimal scan results.

\*1: Easy UI mode only.

\*2: Requires optional MX-EB20.



Home screen

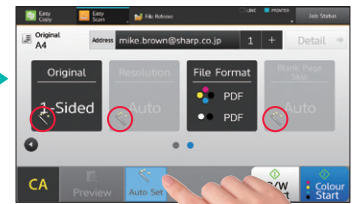

Easy Scan mode

## Automated settings that match the document

The MFP can tell whether a document being scanned is colour or B/W. If it is B/W, it can automatically select the optimal setting for text—monochrome or greyscale.

## Corrects skewed documents

The MFP detects skewed documents\* and automatically adjusts them, so you don’t have to re-scan them.

\*PDF format only.



## Easy, High-Quality Scanning

Through an advanced three-step process, Auto Colour Mode provides faithful and fully automated scanning in both colour and B/W—all with a simple press of the Start button. Here’s how it works: Auto Colour Selection automatically determines whether a page is colour or B/W. Auto Original Type Selection then analyses page contents to distinguish between different components (such as photos and text) and selects the appropriate mode. Finally, Background Suppression automatically removes unnecessary background colour.

# STRONGER SECURITY

- Want to protect confidential information
- Want first-rate data safeguards
- Want user peace of mind

## Network Security and Access Control

- **S/MIME** provides secure email communications\*  
\*Only when emailing scanned data.
- **SSL** (secure sockets layer) and **IPsec** data encryption technologies ensure secure network communications
- **User Authentication** prevents unauthorised MFP use by requiring access passwords
- **Active Directory®** enables integrated management of user credentials, thereby providing a highly secure and efficient environment for system administrators
- **Image Job Log\*** creates and externally stores an image file (PDF) and a log file (XML) for each job. This helps identify unauthorised use of the MFP.  
\*Contact a Sharp customer representative for details on activating this function.

## Document/Data/System Protection

- **Tracking Information Print** prints the MFP user's name, the date, job ID, and other specifics on printouts
- **Firmware self-recovery** prevents data leaks and firmware damage by automatically restoring files when abnormal activity is detected
- Retained data can be **erased** when it's time to replace the MFP, preventing the leakage of confidential information



## System Configuration

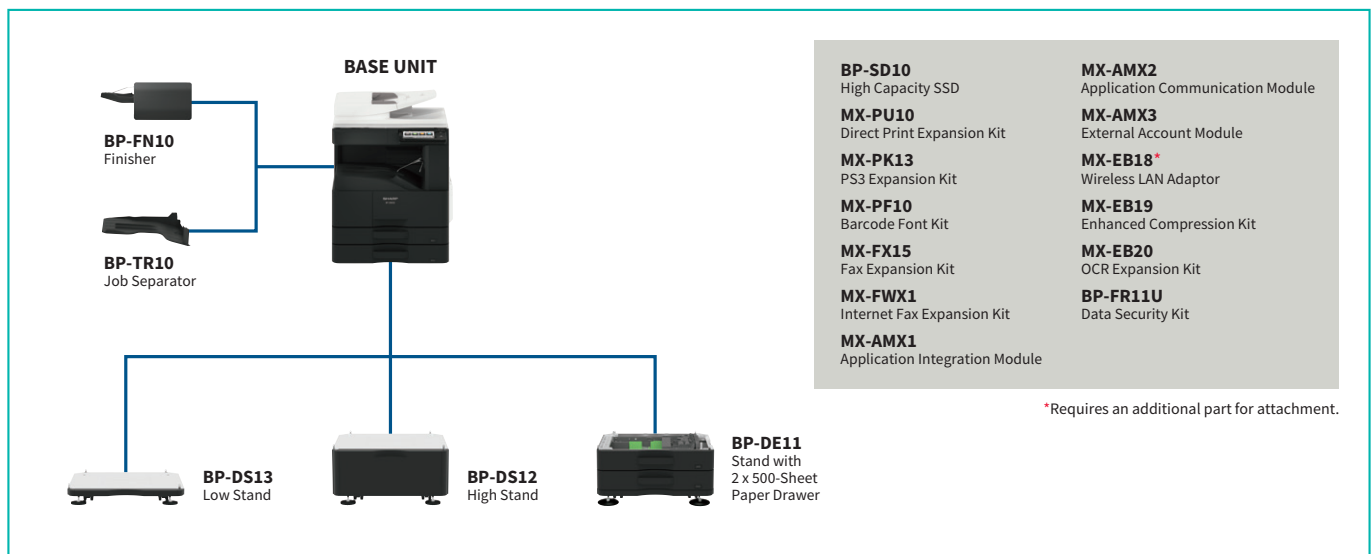

Certain optional equipment may not be available in some areas.

## Specifications for Optional Equipment

### BP-TR10 Job Separator

Paper size	A3 (11" x 17") to A6 (5 1/2" x 8 1/2")* <sup>1</sup>
Paper capacity	100 sheets (A4, 8 1/2" x 11")

### BP-FN10 Finisher

Paper size	Non offset	A3 (11" x 17") to A6 (5 1/2" x 8 1/2")* <sup>1</sup>
	Offset	A3 (11" x 17") to A5* <sup>2</sup> (8 1/2" x 11")
	Staple	A3 (11" x 17") to B5 (8 1/2" x 11")
Paper capacity	Non offset/offset	500 sheets (A4 or smaller), 250 sheets (B4 or larger)
	Staple	30 sets or 500 sheets (A4 or smaller), 30 sets or 250 sheets (B4 or larger)
Stapling capacity		50 sheets (A4, B5), 30 sheets (A3, B4)
Staple position		1 location (rear)

### BP-DE11 Stand with 2 x 500-Sheet Paper Drawer

Paper size	Upper and lower tray	A3 (11" x 17") to A5 (5 1/2" x 8 1/2")* <sup>3</sup>
Paper capacity	Upper and lower tray	500 sheets each

Note: All specifications relating to paper capacity refer to 80 g/m<sup>2</sup> paper.

\*1: Only short-edge feeding can be used with A6 (5 1/2" x 8 1/2") paper.

\*2: Only long-edge feeding can be used with A5 paper.

\*3: Only short-edge feeding can be used with A5 (5 1/2" x 8 1/2") paper.

## SPECIFICATIONS

### General

Type	Desktop	
Engine speed	A4 (8 1/2" x 11")*1: Max. 35/31/28 ppm A3 (11" x 17")*: Max. 19/17/17 ppm	
Control panel display	7.0-inch colour LCD touchscreen	
Paper size	Max. A3 (11" x 17"), min. A6 (5 1/2" x 8 1/2")*2	
Paper capacity (80 g/m <sup>2</sup> )	Standard: 1,100 sheets (2 x 500-sheet tray and 100-sheet multi bypass tray) Maximum: 2,100 sheets (1,100 sheets & optional 2 x 500-sheet tray) Tray 1: 60 g/m <sup>2</sup> to 105 g/m <sup>2</sup> (16 lbs bond to 28 lbs bond) Trays 2-4: 60 g/m <sup>2</sup> to 200 g/m <sup>2</sup> (16 lbs bond to 110 lbs index) Multi bypass tray: 55 g/m <sup>2</sup> to 200 g/m <sup>2</sup> (13 lbs bond to 110 lbs index)	
Paper weight		
Warm-up time*3	BP-30M35: 20 sec.*4 BP-30M31/30M28: 19 sec.*4	
Memory	Standard: 4 GB (copy/print shared)	128 GB SSD*5
Power requirements	Rated local AC voltage ±10%, 50/60 Hz	
Power consumption	Max. 1.45 kW (110V, 220 V to 240 V)	
Dimensions (W x D x H)	620 x 614 x 830 mm (24 27/64" x 24 3/16" x 32 11/16")	
Weight (approx.)	49 kg (108.1 lbs)	

### Copier

Original paper size	Max. A3 (11" x 17")
First copy time*7	BP-30M35: 4.0 sec. BP-30M31/30M28: 4.3 sec.
Continuous copy	Max. 9,999 copies
Resolution	Scan: 600 x 600 dpi, 600 x 400 dpi Print: 600 x 600 dpi
Gradation	Equivalent to 256 levels
Zoom range	25% to 400% (25% to 200% using RSPF) in 1% increments
Preset copy ratios	Metric: 10 ratios (5R/5E), inch: 8 ratios (4R/4E)

### Scanner

Scan method	Push scan (via control panel) Pull scan (TWAIN-compliant application)
Scan speed*8	Colour & B/W: Max. 60 originals/min.
Resolution	Push scan: 100, 150, 200, 300, 400, 600 dpi Pull scan: 75, 100, 150, 200, 300, 400, 600 dpi 50 dpi to 9,600 dpi via user setting*9
File formats	TIFF, PDF, PDF/A-1a*10, PDF/A-1b, encrypted PDF, XPS, compact PDF*11*12, JPEG*12, searchable PDF*10, OOXML (pptx, xlsx, docx)*10, text (TXT [UTF-8])*10, rich text (RTF)*10
Scan destinations	Scan to email/desktop*13/FTP server/network folder (SMB)/USB drive/local drive

- \*1: Long-edge feeding.
- \*2: Only short-edge feeding can be used with A6 (5 1/2" x 8 1/2") paper.
- \*3: In a standard measurement environment. May vary depending on operating conditions and environment.
- \*4: When starting the MFP via the power button. 30 sec. (BP-30M35) or 29 sec. (BP-30M31/30M28) when starting via the main power switch.
- \*5: SSD capacity depends on procurement and sourcing status.
- \*6: Replacing the standard-equipped SSD with the optional BP-SD10 increases SSD capacity to 512 GB.
- \*7: Long-edge feeding of A4 (8 1/2" x 11") sheets from 1st paper tray, using document glass, MFP in fully ready condition. May vary depending on operating conditions and environment.
- \*8: Based on Sharp's A4 standard chart, using document feeder, long-edge feeding, one-sided scanning, and factory default settings. Scan speed will vary depending on the type of document and the scan settings.
- \*9: Resolution will vary depending on the size of the scanned area.
- \*10: Requires optional MX-EB20.
- \*11: Requires optional MX-EB19.
- \*12: Colour/greyscale only.
- \*13: Requires Network Scanner Tool Lite.
- \*14: Storage capacity will vary depending on the type of document and the scan settings.
- \*15: Some features require optional equipment.
- \*16: Requires optional MX-EB18. Availability of this option varies by country/region.
- \*17: Requires optional MX-PK13 for Mac OS.
- \*18: Based on Sharp's standard chart with approx. 700 characters (A4 or 8 1/2" x 11" long-edge feeding) at standard resolution in Super G3 mode, 33,600 bps, JBIG compression.

### Document Filing

Document filing capacity*14	[Standard] Main and custom folders: Max. 5,000 pages or 500 files Quick file folder: Max. 5,000 pages or 500 files [Option] Main and custom folders: Max. 20,000 pages or 3,000 files Quick file folder: Max. 10,000 pages or 1,000 files
Stored jobs*15	Copy, print, scan, fax
Storage folders	Quick file folder, main folder, custom folder (max. 1,000 folders)

### Printer

Resolution	1,200 x 600 dpi, 600 x 600 dpi
Interface	USB 2.0 (host, high-speed), 10Base-T/100Base-TX/1000Base-T, wireless LAN (IEEE 802.11 b/g/n)*16
Supported OS*17	Windows Server® 2012, Windows Server® 2012 R2, Windows Server® 2016, Windows Server® 2019, Windows® 8.1, Windows® 10 Mac OS 10.9, 10.10, 10.11, 10.12, 10.13, 10.14, 10.15, 11 TCP/IP
Network protocols	TCP/IP
Printing protocols	LPR, Raw TCP (port 9100), POP3 (email printing), HTTP, FTP for downloading print files, IPP, SMB, WSD
PDL	Standard: PCL 6 emulation Option: Adobe® PostScript® 3™
Available fonts	80 fonts for PCL, 139 fonts for Adobe PostScript 3

### Facsimile (requires optional MX-FX15)

Compression method	MH/MR/MMR/JBIG
Communication protocol	Super G3/G3
Transmission time	Less than 3 seconds*18
Modem speed	33,600 bps to 2,400 bps with automatic fallback
Transmission resolution	From Standard (203.2 x 97.8 dpi) to Ultra Fine (406.4 x 391 dpi)
Recording size	A3 to A5 (11" x 17" to 5 1/2" x 8 1/2")
Memory	1 GB (built-in)
Greyscale levels	Equivalent to 256 levels

- Design and specifications are subject to change without prior notice.
- ENERGY STAR is a registered trademark owned by the US Environmental Protection Agency. The ENERGY STAR guidelines apply to products only in the US, Canada, and Japan.
- Gmail, Android, and Google Drive are trademarks of Google LLC. The Google Drive trademark is used with permission from Google LLC. Microsoft, OneDrive, SharePoint, Active Directory, Windows Server, and Windows are either registered trademarks or trademarks of Microsoft Corporation in the US and/or other countries. QR Code is a registered trademark of DENSO WAVE INCORPORATED in Japan and other countries. AirPrint and Mac are trademarks of Apple Inc., registered in the US and other countries. Box is a trademark, service mark, or registered trademark of Box, Inc. Dropbox is a trademark or registered trademark of Dropbox, Inc. PCL is a registered trademark of Hewlett-Packard Company. Adobe and PostScript 3 are either registered trademarks or trademarks of Adobe in the US and/or other countries. Qualcomm DirectOffice is a product of Qualcomm Technologies, Inc. and/or its subsidiaries. Qualcomm is a trademark of Qualcomm Incorporated, registered in the US and other countries. DirectOffice is a trademark of CSR Imaging US, LP, registered in the US and other countries. All other brand names and product names may be trademarks or registered trademarks of their respective owners.

Qualcomm® DirectOffice™

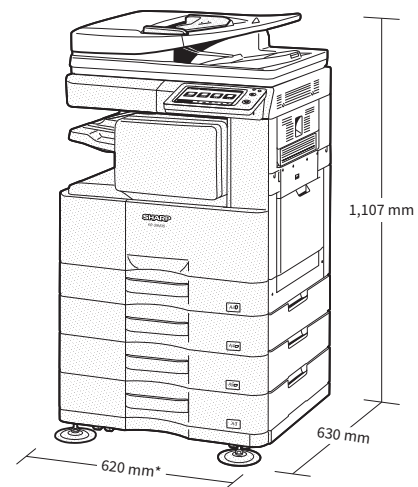

\*Including adjuster.  
1,081 mm when finisher tray and multi bypass tray are extended. Shown with optional equipment.

Distributed by:

# SHARP